



Britax PMG Limited

Britax PMG Limited, Bessingby Industrial Estate,
Bridlington, Yorkshire, England YO16 4SJ
t. +44 (0) 1262 670161 f. +44 (0) 1262 605666 e. enquiries@britax-pmg.com

Light Bars

Product Catalogue

The products detailed in this catalogue represent our current range, and whilst every effort has been made to ensure accuracy of the information supplied, customers are requested to satisfy themselves of the suitability of any products required.

Full terms & conditions available at www.britax-pmg.com



CAT LB14



Britax is a registered trademark of and used under licence from a member of the Britax group of companies.



Light Bars

Product Catalogue



Britax PMG Limited is a world-class supplier of mandatory and auxiliary vehicle lighting, amber hazard warning lighting and rear view mirrors to both vehicle Original Equipment Manufacturers (OEMs) and the commercial vehicle after market. Our equipment can be found on all types of vehicle, including cars, vans, trucks, trailers, tractors, buses, coaches, recovery trucks and construction machinery.

Our quality range of beacons, lightbars, lamps, reflectors, switches, mirrors and wiper systems are sold all around the world through a comprehensive network of distributors. As part of the ECCO Safety Group, the company has access to manufacturing facilities in nine locations on four continents, along with an additional four international sales offices in Europe, Australia and China, together employing 900 team-members.

CHOOSING YOUR LIGHT BAR	04
MINI BARS	06
MICRO BARS	07
A127 SERIES LOW PROFILE LED BARS CODE 3	07
A6 SERIES AEROLITE BARS	08
A13 SERIES LOW PROFILE LED BARS	08
A6 SERIES RECOVERY & SPECIALIST BARS	10
SIGN PLATE LETTERING OPTIONS	12
SPARES	14
INDEX	18

BRITAX is the registered trademark of, and is used under licence from, a member of the BRITAX group of companies.

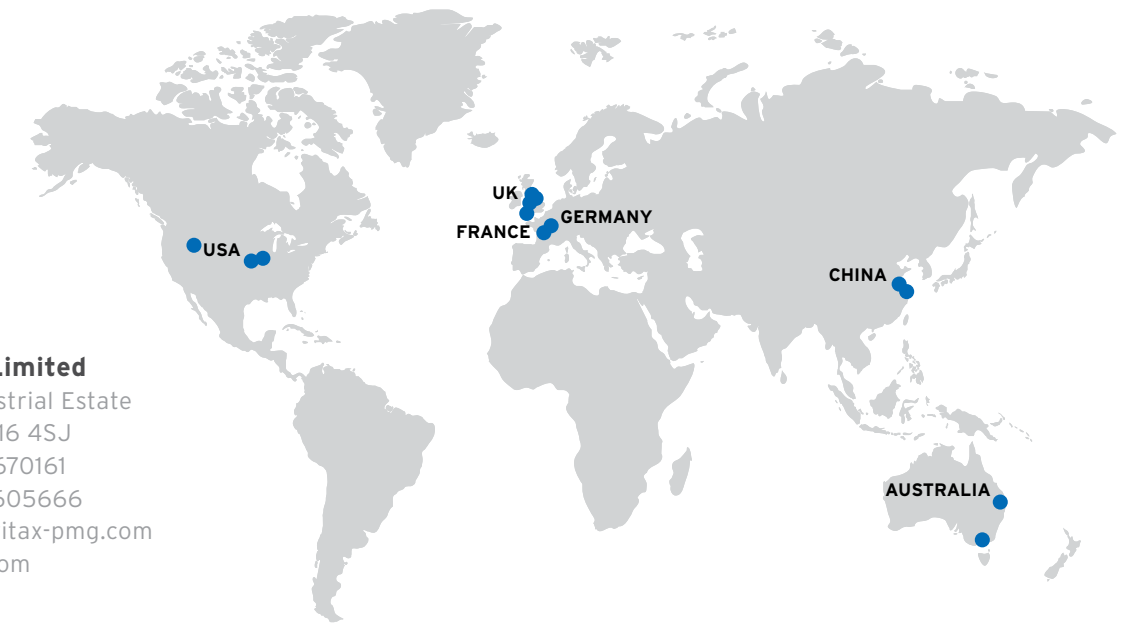

Britax PMG Limited
Bessingby Industrial Estate
Bridlington, YO16 4SJ
t. +44 (0)1262 670161
f. +44 (0)1262 605666
e. enquiries@britax-pmg.com
w. britax-pmg.com



Choosing Your Light Bar

A quick guide to ensure that the lightbar you choose is the right one for you.

Style

MICRO A100 SERIES LED

07

Un-coloured polycarbonate lens, 277mm, available as single bolt fixing or temporary magnetic fixing. Multi-flash pattern, low current consumption.



MICRO A500 SERIES LED

07

Un-coloured lens (non R65) and amber lens (R65), 248mm, available as single bolt fixing or temporary magnetic fixing. Selectable flash patterns, low current consumption.



MINI A420 SERIES ROTATING, XENON,LED

06

Amber polycarbonate lens, 420mm with a choice of primary light sources. Rotating version is ECE R65 approved. Single bolt fixing or temporary magnetic fixing.



MINI A480 & A490 SERIES LOW PROFILE LED

06

Amber polycarbonate lens 420mm low profile to compliment modern vehicle design. A480 is non R65 A490 is R65 approved.



CODE 3 LOW PROFILE LIGHTBARS

07



Available in sizes 571mm, 914mm, 1194mm & 1473mm the range is very low profile The product is a joint Britax / Code 3 bar and can be specified in R65 approved versions.

A6SERIES ROTATING, XENON, LED

06

An extensive range of permanent fix bars in lengths, 520mm, 750mm, 770mm, 1000mm, 1250mm and 1500mm. A choice of primary light sources with illuminated sign plate.



A6 SERIES 'SPECIALIST' ROTATING, LED

12



Available in sizes 1000mm, 1250mm and 1500mm the bar can be specified with externally mounted work lamps and stop/tail/direction indicator lamps or LED warning modules.

A13 SERIES LOW PROFILE LED

08



Un-coloured or amber polycarbonate lens, low profile to complement modern vehicle design. Available in 770mm, 1000mm, 1250mm, 1500mm with dual voltage modules.

Size

277MM

A100 SERIES

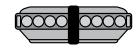

248MM

A500 SERIES



420MM

A420, A430, A440, A450, A480, A490 SERIES



520MM

A6 AEROLITE SERIES



750MM

A6 AEROLITE SERIES



770MM

A6 AEROLITE, A13 LOW PROFILE SERIES



1000MM

A6 AEROLITE, A13 LOW PROFILE SERIES



1250MM

A6 AEROLITE, A13 LOW PROFILE SERIES



1500MM

A6 AEROLITE, A13 LOW PROFILE SERIES



Icon Key



ROTATING

A static halogen bulb with motor driven reflector turning through 360°



XENON

High energy pulse with light being directed through a supplementary Fresnel lens



LED

Very latest technology with multi-diode modules offering high performance and low current consumption.



ECE REG 65

Approved to ECE Regulation 65

DIMENSIONS

A6 SERIES

A13 SERIES

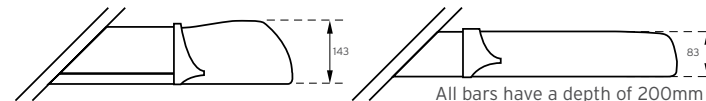

Features

Feature	07		06		06		06		06		12		08
	A500 Series	A100 Series	A420 Series	A430 Series	A450 Series	A480 Series	A490 Series	A6 Series	A6 Series Specialist	A13 Series			
Dedicated voltage 12v or 24v			•						•	•			
Multi-voltage	•	•		•	•	•	•	•	•	•	•	•	
Rotating non Reg 65									•				
Rotating Reg 65			•						•	•			
Xenon				•					•				
LED non Reg 65	•	•			•	•		•	•			•	
LED Reg 65	•							•	•	•	•	•	
Magnetic fixing	•	•	•	•	•	•	•						
Direct to roof fixing	•	•	•	•	•	•	•	•	•	•	•	•	
Outer lens amber	•		•	•	•	•	•	•	•	•	•	•	
Outer lens un-coloured	•	•						•				•	
Sign plate								•	•				
Sign plate illumination / lettering								•	•				
EMC compliance	•	•	•	•	•	•	•	•	•	•	•	•	
Selectable flash pattern	•												
Supplementary stop/tail/DI											•		
Supplementary work lamps											•		
Size													
277mm		•											
248mm	•												
420mm			•	•	•	•	•						
520mm									•				
750mm									•				
770mm									•			•	
1000mm									•	•		•	
1250mm									•	•		•	
1500mm									•	•		•	

FAQs

Q: When do I need a light bar?

A: It is advised that an amber warning light is used in any hazardous situation where vehicles are operating outside of normally expected parameters, it is 'good practice' and will ensure compliance with health & safety guidelines.

Q: What is the fixing method?

A: Britax light bars can be specified with magnetic or permanent bolt on fixings. Magnetic options are only on bars up to 420mm and are intended for temporary use only. The product carries a speed warning which should be observed.

Q: What length light bar will I need?

A: The length of the bar will depend on the size of vehicle it is to be mounted on and the availability of a suitable mounting surface. Generally bars up to 420 mm are suitable for cars, bars 420 - 1000mm for vans and light commercial vehicles and bars 1000mm - 1500mm for heavy commercial vehicles. In all cases the bar must be mounted in strict accordance with the fitting instructions supplied with the product.

Q: Are all fixings included?

A: Yes all bolts and /or brackets are included with each bar.

Q: Do the bars meet current European approvals?

A: Yes within the range bars will comply with the requirements of ECE Regulation 65 and the latest approvals for electro-magnetic compatibility (CE mark).

Q: What is 'Chapter 8'?

A: 'Chapter 8' is an extract from the DoT document "Traffic Safety Measure and Signs for Road Works and Temporary Situations" which states that vehicles stopping on highways for works purposes or inspections shall be equipped with either a roof mounted amber warning light bar, comprising at least two independent light sources OR two independent roof mounted amber warning beacons, visible through 360°. Warning beacons or light bars must conform to ECE Regulation 65.

Q: Do any bars allow compliance with the UK requirement 'Chapter 8'?

A: Yes any light bar that is ECE Regulation 65 approved gives compliance with 'Chapter 8'.

Q: Is full specification information including current draw and input voltage available?

A: Yes check our website for a more detailed technical specification www.britax-pmg.com or call +44 (0)1262 670161 and speak to Technical Services.

Lightbars

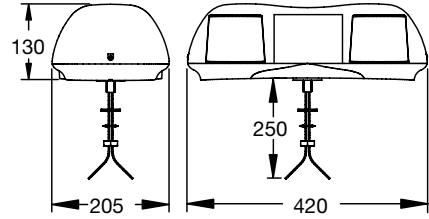

A420/A430/A450 SERIES MINI LIGHT BARS

Lens Colour	Light Source	Fixing	No of Modules	Voltage	R 65 approved	Part No.
Amber	Rotating	1 bolt	2	12V	Yes	A421.00.12V
Amber	Rotating	1 bolt	2	24V	Yes	A421.00.24V
Amber	Rotating	magnetic	2	12V	Yes	A424.00.12V
Amber	Rotating	magnetic	2	24V	Yes	A424.00.24V
Amber	Xenon	1 bolt	2	dual voltage	No	A431.00.DV
Amber	Xenon	magnetic	2	dual voltage	No	A434.00.DV
Amber	LED	1 bolt	2	dual voltage	No	A451.00.LMV
Amber	LED	magnetic	2	dual voltage	No	A454.00.LMV

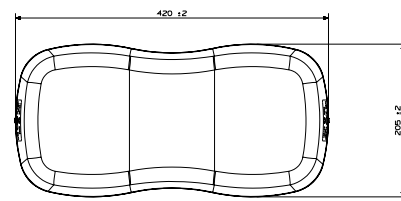
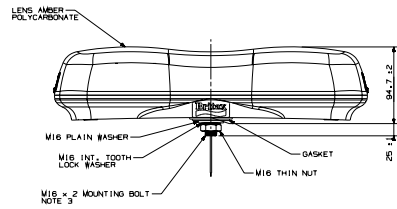

A480/A490 SERIES LOW PROFILE MINI BARS

Lens Colour	Light Source	Fixing	No of Modules	Voltage	R 65 approved	Part No.
Amber	LED	1 bolt	8	dual voltage	No	A481.00.LDV
Amber	LED	magnetic	8	dual voltage	No	A484.00.LDV
Amber	LED	1 bolt	6	dual voltage	Yes	A491.00.LDV
Amber	LED	magnetic	6	dual voltage	Yes	A494.00.LDV
Un-coloured	LED	1 bolt	6	dual voltage	Yes	A491.40.LDV
Un-coloured	LED	magnetic	6	dual voltage	Yes	A494.40.LDV

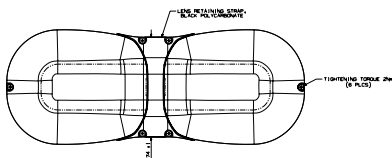
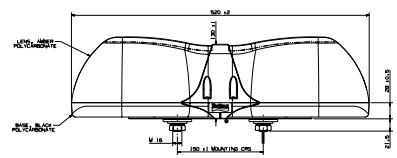

A6 SERIES BARS 520MM

Lens Colour	Light Source	Fixing	No of Modules	Voltage	R 65 approved	Part No.
Amber	Rotating	2 bolt	2	12V	Yes	A6202.000.12V
Amber	Rotating	2 bolt	2	24V	Yes	A6202.000.24V
Amber	Xenon	2 bolt	2	dual voltage	No	A6302.000.DV
Amber	LED	2 bolt	2	dual voltage	No	A6702.000.DV
Amber	LED	2 bolt	2	dual voltage	Yes	A6602.000.LDV

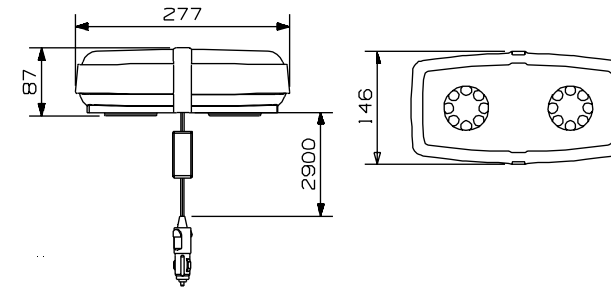

A100 SERIES MICRO BARS

Lens Colour	Light Source	Fixing	No of Modules	Voltage	R 65 approved	Part No.
Un-coloured	LED	1 bolt	6	dual voltage	No	A101.00.LDV
Un-coloured	LED	magnetic	6	dual voltage	No	A100.00.LDV

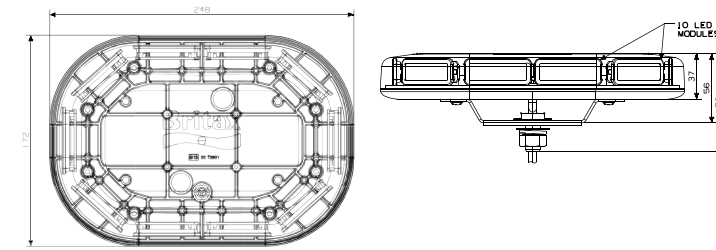

A500 SERIES MICRO BARS

Lens Colour	Light Source	Fixing	No of Modules	Voltage	R 65 approved	Part No.
Un-coloured	LED	1 bolt	10	dual voltage	No	A501.00.LDV
Un-coloured	LED	magnetic	10	dual voltage	No	A504.00.LDV.KIT*
Amber	LED	1 bolt	10	dual voltage	Yes	A511.00.LDV
Amber	LED	magnetic	10	dual voltage	Yes	A514.00.LDV.KIT*

* = supplied with protective neoprene cover



Low profile un-coloured lens LED light bars only 53mm high and providing high power LED warning. Choice of lengths 571mm -1473mm. Built to order, lead times apply.



A127 SERIES CODE 3 LOW PROFILE LIGHTBARS

Length	Lens Colour	Light Source	Fixing	No of Modules	Voltage	R 65 approved	Part No.
571mm	Un-coloured	Amber LED	4 bolt	8	Dual voltage	No	A12708.000.DV
914mm	Un-coloured	Amber LED	4 bolt	8	Dual voltage	No	A12738.000.DV
914mm	Un-coloured	Amber LED	4 bolt	16	Dual voltage	No	A12738.001.DV
914mm	Un-coloured	Amber LED	4 bolt	10	Dual voltage	Yes	A12738.100.DV
1194mm	Un-coloured	Amber LED	4 bolt	12	Dual voltage	No	A12759.000.DV
1194mm	Un-coloured	Amber LED	4 bolt	10	Dual voltage	Yes	A12759.100.DV
1473mm	Un-coloured	Amber LED	4 bolt	12	Dual voltage	No	A12779.000.DV



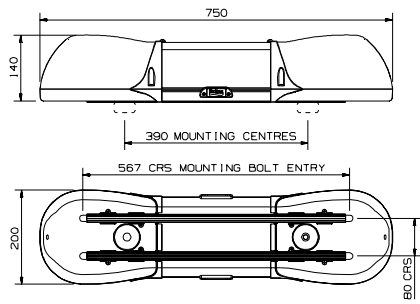

A6 SERIES BARS 750MM 2 MODULE ONLY

Lens Colour	Light Source	Fixing	Illuminated centre	No of Modules	Voltage	R 65 approved	Part No.
Amber	Rotating	4 bolt	No	2	12V	Yes	A6212.100.12V
Amber	Rotating	4 bolt	Yes	2	12V	Yes	A6212.200.12V
Amber	Rotating	4 bolt	No	2	24V	Yes	A6212.100.24V
Amber	Rotating	4 bolt	Yes	2	24V	Yes	A6212.200.24V
Amber	Xenon	4 bolt	No	2	dual voltage	No	A6312.100.DV
Amber	Xenon	4 bolt	Yes	2	dual voltage	No	A6312.200.LDV
Amber	LED	4 bolt	No	2	dual voltage	No	A6712.100.DV
Amber	LED	4 bolt	Yes	2	dual voltage	No	A6712.200.LDV
Amber	LED	4 bolt	No	2	dual voltage	Yes	A6612.100.LDV
Amber	LED	4 bolt	Yes	2	dual voltage	Yes	A6612.200.LDV

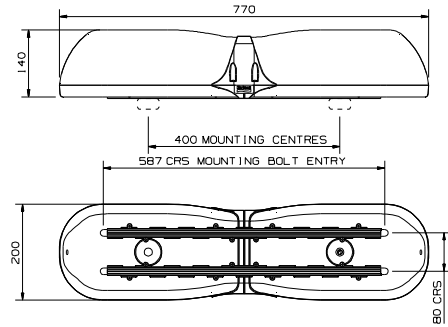

A6 SERIES BARS 770MM 4 MODULE ONLY

Lens Colour	Light Source	Fixing	Centre Section	No of Modules	Voltage	R 65 approved	Part No.
Amber	Rotating	4 bolt	No	4	12V	Yes	A6124.000.12V
Amber	Rotating	4 bolt	No	4	24V	Yes	A6124.000.24V
Amber	Rotating	4 bolt	No	4	12V	No	A6224.000.12V
Amber	Rotating	4 bolt	No	4	24V	No	A6224.000.24V
Amber	Xenon	4 bolt	No	4	dual voltage	No	A6324.000.DV
Amber	LED	4 bolt	No	4	dual voltage	No	A6724.000.DV
Amber	LED	4 bolt	No	4	dual voltage	Yes	A6624.000.LDV

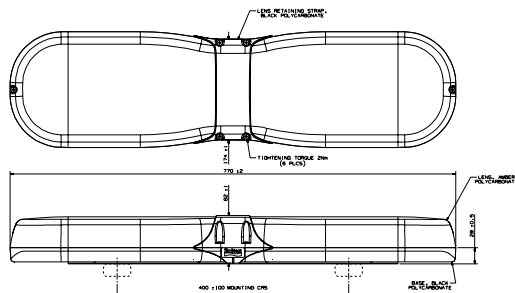

A13 SERIES BARS 770MM LOW PROFILE LED

Lens Colour	Light Source	Fixing	Centre Section	No of Modules	Voltage	R 65 approved	Part No.
Amber	LED	4 bolt	No	12	dual voltage	Yes	A13720.000.DV
Un-coloured	LED	4 bolt	No	12	dual voltage	Yes	A13720.040.DV
Amber	LED	4 bolt	No	12	dual voltage	No	A13722.000.LDV
Un-coloured	LED	4 bolt	No	12	dual voltage	No	A13722.040.LDV



A6 SERIES BARS 1000MM 2 + 4 MODULE

Lens Colour	Light Source	Fixing	Illuminated centre	No of Modules	Voltage	R 65 approved	Part No.
Amber	Rotating	4 bolt	No	2	12V	Yes	A6242.100.12V
Amber	Rotating	4 bolt	Yes	2	12V	Yes	A6242.200.12V
Amber	Rotating	4 bolt	No	2	24V	Yes	A6242.100.24V
Amber	Rotating	4 bolt	Yes	2	24V	Yes	A6242.200.24V
Amber	Rotating	4 bolt	No	4	12V	No	A6234.100.12V
Amber	Rotating	4 bolt	Yes	4	12V	No	A6234.200.12V
Amber	Rotating	4 bolt	No	4	24V	No	A6234.100.24V
Amber	Rotating	4 bolt	Yes	4	24V	No	A6234.200.24V
Amber	Rotating	4 bolt	No	4	12V	Yes	A6134.100.12V
Amber	Rotating	4 bolt	Yes	4	12V	Yes	A6134.200.12V
Amber	Rotating	4 bolt	No	4	24V	Yes	A6134.100.24V
Amber	Rotating	4 bolt	Yes	4	24V	Yes	A6134.200.24V
Amber	Xenon	4 bolt	No	2	dual voltage	No	A6342.100.DV
Amber	Xenon	4 bolt	Yes	2	dual voltage	No	A6342.200.LDV
Amber	Xenon	4 bolt	No	4	dual voltage	No	A6334.100.DV
Amber	Xenon	4 bolt	Yes	4	dual voltage	No	A6334.200.LDV
Amber	LED	4 bolt	No	2	dual voltage	No	A6742.100.DV
Amber	LED	4 bolt	Yes	2	dual voltage	No	A6742.200.LDV
Amber	LED	4 bolt	No	2	dual voltage	Yes	A6642.100.LDV
Amber	LED	4 bolt	Yes	2	dual voltage	Yes	A6642.200.LDV
Amber	LED	4 bolt	No	4	dual voltage	No	A6734.100.DV
Amber	LED	4 bolt	Yes	4	dual voltage	No	A6734.200.LDV
Amber	LED	4 bolt	No	4	dual voltage	Yes	A6634.100.LDV
Amber	LED	4 bolt	Yes	4	dual voltage	Yes	A6634.200.LDV

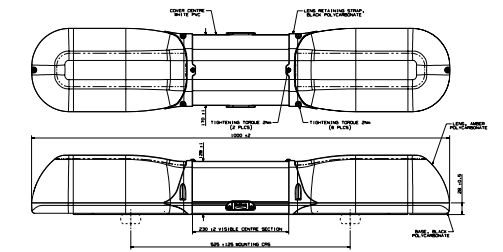

A13 SERIES BARS 1000MM LOW PROFILE LED

Lens Colour	Light Source	Fixing	Illuminated centre	No of Modules	Voltage	R 65 approved	Part No.
Amber	LED	4 bolt	No	12	dual voltage	Yes	A13730.100.DV
Un-coloured	LED	4 bolt	No	12	dual voltage	Yes	A13730.140.DV
Amber	LED	4 bolt	4 x 3-way	16	dual voltage	Yes	A13730.200.DV
Un-coloured	LED	4 bolt	4 x 3-way	16	dual voltage	Yes	A13730.240.DV
Amber	LED	4 bolt	No	12	dual voltage	No	A13732.100.LDV
Un-coloured	LED	4 bolt	No	12	dual voltage	No	A13732.140.LDV
Amber	LED	4 bolt	4 x 4-way	16	dual voltage	No	A13732.200.LDV
Un-coloured	LED	4 bolt	4 x 4-way	16	dual voltage	No	A13732.240.LDV

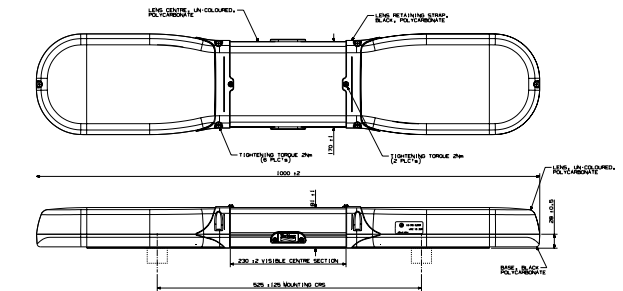

ALL XENON AND LED A6
DUAL VOLTAGE
SIGN PLATE ILLUMINATION
WHEN SPECIFIED

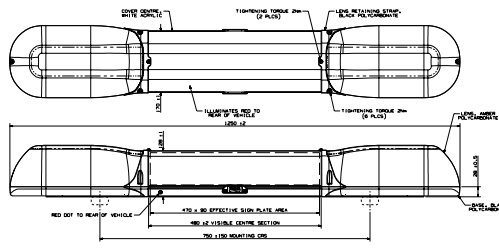

A6 SERIES BARS 1250MM 2 + 4 MODULE

Lens Colour	Light Source	Fixing	Illuminated centre	No of Modules	Voltage	R 65 approved	Part No.
Amber	Rotating	4 bolt	No	2	12V	Yes	A6262.100.12V
Amber	Rotating	4 bolt	Yes	2	12V	Yes	A6262.200.12V
Amber	Rotating	4 bolt	No	2	24V	Yes	A6262.100.24V
Amber	Rotating	4 bolt	Yes	2	24V	Yes	A6262.200.24V
Amber	Rotating	4 bolt	No	4	12V	No	A6254.100.12V
Amber	Rotating	4 bolt	Yes	4	12V	No	A6254.200.12V
Amber	Rotating	4 bolt	No	4	24V	No	A6254.100.24V
Amber	Rotating	4 bolt	Yes	4	24V	No	A6254.200.24V
Amber	Rotating	4 bolt	No	4	12V	Yes	A6154.100.12V
Amber	Rotating	4 bolt	Yes	4	12V	Yes	A6154.200.12V
Amber	Rotating	4 bolt	No	4	24V	Yes	A6154.100.24V
Amber	Rotating	4 bolt	Yes	4	24V	Yes	A6154.200.24V
Amber	Xenon	4 bolt	No	2	dual voltage	No	A6362.100.DV
Amber	Xenon	4 bolt	Yes	2	dual voltage	No	A6362.200.LDV
Amber	Xenon	4 bolt	No	4	dual voltage	No	A6354.100.DV
Amber	Xenon	4 bolt	Yes	4	dual voltage	No	A6354.200.LDV
Amber	LED	4 bolt	No	2	dual voltage	No	A6762.100.DV
Amber	LED	4 bolt	Yes	2	dual voltage	No	A6762.200.LDV
Amber	LED	4 bolt	No	2	dual voltage	Yes	A6662.100.LDV
Amber	LED	4 bolt	Yes	2	dual voltage	Yes	A6662.200.LDV
Amber	LED	4 bolt	No	4	dual voltage	No	A6754.100.DV
Amber	LED	4 bolt	Yes	4	dual voltage	No	A6754.200.LDV
Amber	LED	4 bolt	No	4	dual voltage	Yes	A6654.100.LDV
Amber	LED	4 bolt	Yes	4	dual voltage	Yes	A6654.200.LDV



A6 SERIES BARS 1500MM 2 + 4 MODULE

Lens Colour	Light Source	Fixing	Illuminated centre	No of Modules	Voltage	R 65 approved	Part No.
Amber	Rotating	4 bolt	No	2	12V	Yes	A6282.100.12V
Amber	Rotating	4 bolt	Yes	2	12V	Yes	A6282.200.12V
Amber	Rotating	4 bolt	No	2	24V	Yes	A6282.100.24V
Amber	Rotating	4 bolt	Yes	2	24V	Yes	A6282.200.24V
Amber	Rotating	4 bolt	No	4	12V	No	A6274.100.12V
Amber	Rotating	4 bolt	Yes	4	12V	No	A6274.200.12V
Amber	Rotating	4 bolt	No	4	24V	No	A6274.100.24V
Amber	Rotating	4 bolt	Yes	4	24V	No	A6274.200.24V
Amber	Rotating	4 bolt	No	4	12V	Yes	A6174.100.12V
Amber	Rotating	4 bolt	Yes	4	12V	Yes	A6174.200.12V
Amber	Rotating	4 bolt	No	4	24V	Yes	A6174.100.24V
Amber	Rotating	4 bolt	Yes	4	24V	Yes	A6174.200.24V
Amber	Xenon	4 bolt	No	2	dual voltage	No	A6382.100.DV
Amber	Xenon	4 bolt	Yes	2	dual voltage	No	A6382.200.LDV
Amber	Xenon	4 bolt	No	4	dual voltage	No	A6374.100.DV
Amber	Xenon	4 bolt	Yes	4	dual voltage	No	A6374.200.LDV
Amber	LED	4 bolt	No	2	dual voltage	No	A6782.100.DV
Amber	LED	4 bolt	Yes	2	dual voltage	No	A6782.200.LDV
Amber	LED	4 bolt	No	2	dual voltage	Yes	A6682.100.DV
Amber	LED	4 bolt	Yes	2	dual voltage	Yes	A6682.200.LDV
Amber	LED	4 bolt	No	4	dual voltage	No	A6774.100.DV
Amber	LED	4 bolt	Yes	4	dual voltage	No	A6774.200.LDV
Amber	LED	4 bolt	No	4	dual voltage	Yes	A6674.100.DV
Amber	LED	4 bolt	Yes	4	dual voltage	Yes	A6674.200.LDV

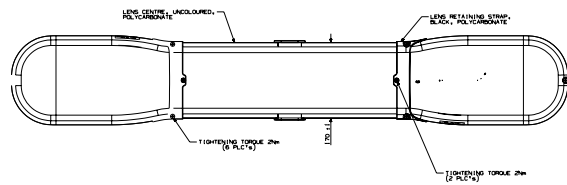
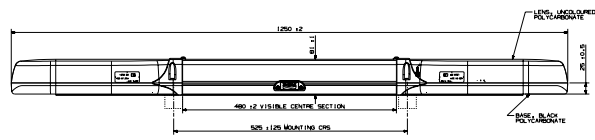
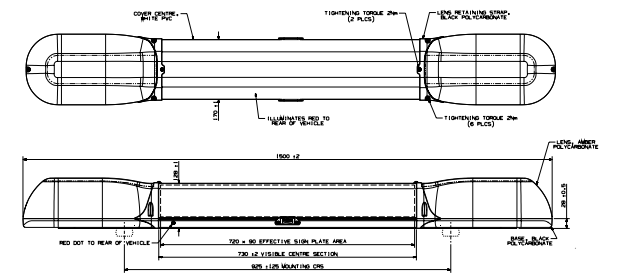

A13 SERIES BARS 1250MM LOW PROFILE LED

Lens Colour	Light Source	Fixing	Illuminated centre	No of Modules	Voltage	R 65 approved	Part No.
Amber	LED	4 bolt	No	12	dual voltage	Yes	A13750.100.DV
Un-coloured	LED	4 bolt	No	12	dual voltage	Yes	A13750.140.DV
Amber	LED	4 bolt	4 x 4-way	16	dual voltage	Yes	A13750.200.DV
Un-coloured	LED	4 bolt	4 x 4-way	16	dual voltage	Yes	A13750.240.DV
Amber	LED	4 bolt	No	12	dual voltage	No	A13752.100.LDV
Un-coloured	LED	4 bolt	No	12	dual voltage	No	A13752.140.LDV
Amber	LED	4 bolt	8 x 4-way	20	dual voltage	No	A13752.200.LDV
Un-coloured	LED	4 bolt	8 x 4-way	20	dual voltage	No	A13752.240.LDV

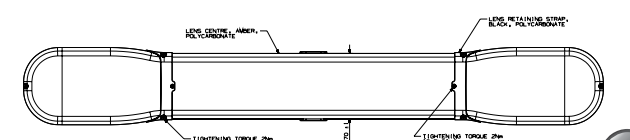
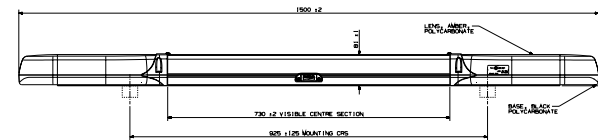

A13 SERIES BARS 1500MM LOW PROFILE LED

Lens Colour	Light Source	Fixing	Illuminated centre	No of Modules	Voltage	R 65 approved	Part No.
Amber	LED	4 bolt	No	12	dual voltage	Yes	A13770.100.DV
Un-coloured	LED	4 bolt	No	12	dual voltage	Yes	A13770.140.DV
Amber	LED	4 bolt	8 x 4-way	20	dual voltage	Yes	A13770.200.DV
Un-coloured	LED	4 bolt	8 x 4-way	20	dual voltage	Yes	A13770.240.DV
Amber	LED	4 bolt	No	12	dual voltage	No	A13772.100.LDV
Un-coloured	LED	4 bolt	No	12	dual voltage	No	A13772.140.LDV
Amber	LED	4 bolt	12 x 4-way	24	dual voltage	No	A13772.200.LDV
Un-coloured	LED	4 bolt	12 x 4-way	24	dual voltage	No	A13772.240.LDV

OVERALL DIMENSIONS
ARE AVAILABLE ON PAGES
9, 10 & 11



SPECIALIST LIGHTBARS

Length	Lens colour	Light Source	Fixing	No of Modules	Voltage	Stop/Tail	DI	Warning Modules	Work Lamps	R 65 approved	Illuminated C/Section	Part No.
1000mm	Amber	LED	4 bolt	2	Dual	No	No	2 x L52	No	Yes	No	A6637.100.LDV
1250mm	Amber	LED	4 bolt	2	Dual	No	No	2 x L52	No	Yes	No	A6657.100.LDV
1500mm	Amber	LED	4 bolt	2	Dual	No	No	2 x L52	No	Yes	No	A6677.100.LDV
1250mm	Amber	LED	4 bolt	2	Dual	Yes	Yes	No	Yes	Yes	Yes	A6656.300.LDV
1500mm	Amber	LED	4 bolt	2	Dual	Yes	Yes	No	Yes	Yes	Yes	A6676.300.LDV
1250mm	Amber	Rotating	4 bolt	2	12V	Yes	Yes	No	No	Yes	Yes	A6546.200.12V
1250mm	Amber	Rotating	4 bolt	2	24V	Yes	Yes	No	No	Yes	Yes	A6546.200.24V
1500mm	Amber	Rotating	4 bolt	2	12V	Yes	Yes	No	No	Yes	Yes	A6556.200.12V
1500mm	Amber	Rotating	4 bolt	2	24V	Yes	Yes	No	No	Yes	Yes	A6556.200.24V
1250mm	Amber	Rotating	4 bolt	2	12V	Yes	Yes	No	Yes	Yes	Yes	A6546.300.12V
1250mm	Amber	Rotating	4 bolt	2	24V	Yes	Yes	No	Yes	Yes	Yes	A6546.300.24V
1500mm	Amber	Rotating	4 bolt	2	12V	Yes	Yes	No	Yes	Yes	Yes	A6556.300.12V
1500mm	Amber	Rotating	4 bolt	2	24V	Yes	Yes	No	Yes	Yes	Yes	A6556.300.24V

SIGN PLATE LETTERING OPTIONS



STANDARD SIGN PLATE OPTIONS

FOR A6 SERIES BARS ONLY 750MM - 1500MM (EXCLUDING 770MM)

Bar Size	No of Modules	Visible sign plate size
750mm	2	220mm
1000mm	2	470mm
1000mm	4	220mm
1250mm	2	720mm
1250mm	4	470mm
1500mm	2	970mm
1500mm	4	720mm

STANDARD ARTWORK

Part No	Artwork Size	Wording	Font Colour	Font Style	Finish
12005.10	500x110	ABNORMAL LOAD	black	Arial bold	gloss
12005.13	300x88	Abnormal Load	black	AS Ormicron	gloss
12005.79	210x90	ANIMAL WARDEN	black	AS Ormicron	gloss
12005.26	486x88	CAUTION	black	AS Ormicron	gloss
12005.87	470x60	CLEANSING	black	AS Ormicron	gloss
12005.101	703x90	CLEANSING	black	AS Ormicron	gloss
12005.77	720x72	DOG SECTION	black	AS Ormicron	gloss
12005.89	475x50	DOG WARDEN	black	AS Ormicron	gloss
12005.86	470x47	ENVIRONMENTAL	black	AS Ormicron	gloss
12005.19	422x86	ESCORT	black	AS Ormicron	gloss
12005.59	220x45	ESCORT	black	AS Ormicron	gloss
12005.109	470x58	FOLLOW ME	black	AS Ormicron	gloss
12005.99	553x90	FOR HIRE	black	AS Ormicron	gloss
12005.49	353x90	HIGHWAY MAINTENANCE	black	AS Ormicron	gloss
12005.64	470x80	HIGHWAY	black	AS Ormicron	gloss
12005.76	470x65	HIGHWAYS	black	AS Ormicron	gloss
12005.91	600x90	HIGHWAYS	black	AS Ormicron	gloss
12005.61	470x47	MOBILE SERVICE	black	AS Ormicron	gloss
12005.36	350x88	MOTORWAY MAINTENANCE	black	AS Ormicron	gloss
12005.85	397x100	PARKS	black	AS Ormicron	gloss
12005.07	300x110	RECOVERY	black	Arial bold	gloss
12005.35	720x88	ROAD SURVEY	black	AS Ormicron	gloss
12005.28	570x88	SECURITY	black	AS Ormicron	gloss
12005.55	460x56	Abnormal Load	black	AS Ormicron	gloss
12005.73	470x70	SECURITY	black	AS Ormicron	gloss
12005.50	460x66	SPREADING	black	AS Ormicron	gloss
12005.57	427x85	SURVEY	black	AS Ormicron	gloss
12005.00	300x110	SURVEYING	black	Arial bold	mat
12005.23	436x88	TOWING	black	AS Ormicron	gloss
12005.22	470x50	TREE CUTTING	black	AS Ormicron	gloss
12005.63	720x56	WASTE MANAGEMENT	black	AS Ormicron	gloss
12005.78	435x88	WATER	black	AS Ormicron	gloss
12005.39	720x70	WATER SERVICES	black	AS Ormicron	gloss
12005.09	300x110	WIDE LOAD	black	Arial bold	gloss
12005.12	500x87	WIDE LOAD	black	AS Ormicron	gloss
12005.110	720x110	WIDE VEHICLE	black	AS Ormicron	gloss

Important Information

- Please note part numbers listed are for one set of lettering only.
- If the message is required front and rear of the bar, order quantity = 2 per part number.
- Bars with illuminated centre sections have a red dot adjacent to the centre denoting red illumination for rear facing.
- Other messages, font styles, font colours and languages can be ordered, please contact our sales team on **+44 (0)1262 670161** for more information.

HIGHWAY MAINTENANCE

The messages **ANIMAL WARDEN, HIGHWAY MAINTENANCE, MOTORWAY MAINTENANCE** are all messages that are on two lines, first word above the second.

- Sign plate lettering material specification:
 - Polymeric calendar vinyl
 - 70 micron face film
 - 5 to 7 years outdoor life.



A6 SERIES BARS 520MM

Part Number	Module	Module Inner Pair	Drive Belt	Link Belt	Lens	Centre Section	Bridge Piece	Bulb Clip	Module Bulb	Centre Sec Bulb	Fresnel Lens
A6202.000.12V	13551.04	N/A	15214	N/A	10519.22	N/A	12343.00	27031	H448	N/A	N/A
A6202.000.24V	13551.04	N/A	15214	N/A	10519.22	N/A	12343.00	27031	H448	N/A	N/A
A6302.000.DV	13002.00	N/A	N/A	N/A	10519.23	N/A	12343.00	N/A	N/A	N/A	10085
A6702.000.DV	13606.53	N/A	N/A	N/A	10519.27	N/A	12343.00	N/A	N/A	N/A	10085

A6 SERIES BARS 750MM 2 MODULE ONLY

Part Number	Module	Module Inner Pair	Drive Belt	Link Belt	Lens	Centre Section	Bridge Piece	Bulb Clip	Module Bulb	Centre Sec Bulb	Fresnel Lens
A6212.100.12V	13551.04	N/A	15214	N/A	10519.22	12345.03	12342.10	27031	H448	N/A	N/A
A6212.200.12V	13551.04	N/A	15214	N/A	10519.22	12345.03	12342.10	27031	H448	L382	N/A
A6212.100.24V	13551.04	N/A	15214	N/A	10519.22	12345.03	12342.10	27031	H466	N/A	N/A
A6212.200.24V	13551.04	N/A	15214	N/A	10519.22	12345.03	12342.10	27031	H466	L241	N/A
A6312.100.DV	13002.00	N/A	N/A	N/A	10519.23	12345.03	12342.10	N/A	N/A	N/A	10085
A6312.200.LDV	13002.00	N/A	N/A	N/A	10519.23	12345.03	12342.10	N/A	N/A	N/A	10085
A6712.100.DV	13606.53	N/A	N/A	N/A	10519.27	12345.03	12342.10	N/A	N/A	L382/L241	10085

A6 SERIES BARS 770MM 4 MODULE ONLY

Part Number	Module	Module Inner Pair	Drive Belt	Link Belt	Lens	Centre Section	Bridge Piece	Bulb Clip	Module Bulb	Centre Sec Bulb	Fresnel Lens
A6124.000.12V	13589.00.12V	13590.00	N/A	15332.00	10518.21	N/A	12343.00	27121	H448	N/A	N/A
A6124.000.24V	13589.00.24V	13590.00	N/A	15332.00	10518.21	N/A	12343.00	27121	H466	N/A	N/A
A6224.000.12V	13551.04	13551.04	15214	N/A	10518.22	N/A	12343.00	27031	H448	N/A	N/A
A6224.000.24V	13551.04	13551.04	15214	N/A	10518.22	N/A	12343.00	27031	H466	N/A	N/A
A6324.000.DV	13002.00	13002.00	N/A	N/A	10518.23	N/A	12343.00	N/A	N/A	N/A	10085
A6724.000.DV	13606.53	N/A	N/A	N/A	10518.28	N/A	12343.00	N/A	N/A	N/A	10085

A6 SERIES BARS 1000MM 2 + 4 MODULE

CENTRE SECTION SUPPORT BAR FOR THIS ITEM 11298.02

Part Number	Module	Module Inner Pair	Drive Belt	Link Belt	Lens	Centre Section	Bridge Piece	Bulb Clip	Module Bulb	Centre Sec Bulb	Fresnel Lens
A6242.100.12V	13551.04	N/A	15214	N/A	10519.22	12345.02	12342.10	27031	H448	N/A	N/A
A6242.200.12V	13551.04	N/A	15214	N/A	10519.22	12345.02	12342.10	27031	H448	L382	N/A
A6242.100.24V	13551.04	N/A	15214	N/A	10519.22	12345.02	12342.10	27031	H466	N/A	N/A
A6242.200.24V	13551.04	N/A	15214	N/A	10519.22	12345.02	12342.10	27031	H466	L241	N/A
A6342.100.DV	13002.00	N/A	N/A	N/A	10519.23	12345.02	12342.10	N/A	N/A	N/A	10085
A6342.200.LDV	13002.00	N/A	N/A	N/A	10519.23	12345.02	12342.10	N/A	N/A	N/A	10085
A6742.100.DV	13606.53	N/A	N/A	N/A	10519.27	12345.02	12342.10	N/A	N/A	N/A	10085
A6742.200.LDV	13606.53	N/A	N/A	N/A	10519.27	12345.02	12342.10	N/A	N/A	N/A	10085

A6 SERIES BARS 1000MM 2 + 4 MODULE

CENTRE SECTION SUPPORT BAR FOR THIS ITEM 11298.03

Part Number	Module	Module Inner Pair	Drive Belt	Link Belt	Lens	Centre Section	Bridge Piece	Bulb Clip	Module Bulb	Centre Sec Bulb	Fresnel Lens
A6234.100.12V	13551.04	13551.04	15214	N/A	10518.22	12345.03	12345.03	27031	H448	N/A	N/A
A6234.200.12V	13551.04	13551.04	15214	N/A	10518.22	12345.03	12345.03	27031	H448	L382	N/A
A6234.100.24V	13551.04	13551.04	15214	N/A	10518.22	12345.03	12345.03	27031	H466	N/A	N/A
A6234.200.24V	13551.041	13551.04	15214	N/A	10518.22	12345.03	12345.03	27031	H466	L382	N/A
A6134.100.12V	3589.00.12V	13590.00	N/A	15332.00	10518.21	12345.03	12345.03	27121	H448	N/A	N/A
A6134.200.12V	3589.00.12V	13590.00	N/A	15332.00	10518.21	12345.03	12345.03	27121	H448	L382	N/A
A6134.100.24V	3589.00.24V	13590.00	N/A	15332.00	10518.21	12345.03	12345.03	27121	H466	N/A	N/A
A6134.200.24V	3589.00.24V	13590.00	N/A	15332.00	10518.21	12345.03	12345.03	27121	H466	L241	N/A
A6334.100.DV	13002.00	13002.00	N/A	N/A	10518.23	12345.03	12345.03	N/A	N/A	N/A	10085
A6334.200.LDV	13002.00	13002.00	N/A	N/A	10518.23	12345.03	12345.03	N/A	N/A	N/A	10085
A6734.100.DV	13606.53	N/A	N/A	N/A	10518.28	12345.03	12345.03	N/A	N/A	N/A	10085
A6734.200.LDV	13606.53	N/A	N/A	N/A	10518.28	12345.03	12345.03	N/A	N/A	N/A	10085

A6 SERIES BARS 1250MM 2 + 4 MODULE

CENTRE SECTION SUPPORT BAR FOR THIS ITEM 11298.01

Part Number	Module	Module Inner Pair	Drive Belt	Link Belt	Lens	Centre Section	Bridge Piece	Bulb Clip	Module Bulb	Centre Sec Bulb	Fresnel Lens
A6262.100.12V	13551.04	N/A	15214	N/A	10519.22	12345.01	12342.10	27031	H448	N/A	N/A
A6262.200.12V	13551.04	N/A	15214	N/A	10519.22	12345.01	12342.10	27031	H448	L382	N/A
A6262.100.24V	13551.04	N/A	15214	N/A	10519.22	12345.01	12342.10	27031	H466	N/A	N/A
A6262.200.24V	13551.04	N/A	15214	N/A	10519.22	12345.01	12342.10	27031	H466	L241	N/A
A6362.100.DV	13002.00	N/A	N/A	N/A	10519.23	12345.01	12342.10	N/A	N/A	N/A	10085
A6362.200.LDV	13002.00	N/A	N/A	N/A	10519.23	12345.01	12342.10	N/A	N/A	N/A	10085
A6762.100.DV	13606.53	N/A	N/A	N/A	10519.27	12345.01	12342.10	N/A	N/A	N/A	10085
A6762.200.LDV	13606.53	N/A	N/A	N/A	10519.27	12345.01	12342.10	N/A	N/A	N/A	10085

A6 SERIES BARS 1250MM 2 + 4 MODULE

CENTRE SECTION SUPPORT BAR FOR THIS ITEM 11298.02

Part Number	Module	Module Inner Pair	Drive Belt	Link Belt	Lens	Centre Section	Bridge Piece	Bulb Clip	Module Bulb	Centre Sec Bulb	Fresnel Lens
A6254.100.12V	13551.04	13551.04	15214	N/A	10518.22	12345.02	12342.10	27031	H448	N/A	N/A
A6254.200.12V	13551.04	13551.04	15214	N/A	10518.22	12345.02	12342.10	27031	H448	L382	N/A
A6254.100.24V	13551.04	13551.04	15214	N/A	10518.22	12345.02	12342.10	27031	H466	N/A	N/A
A6254.200.24V	13551.04	13551.04	15214	N/A	10518.22	12345.02	12342.10	27031	H466	L241	N/A
A6154.100.12V	3589.00.12V	13590.00	N/A	15332.00	10518.21	12345.02	12342.10	27121	H448	N/A	N/A
A6154.200.12V	3589.00.12V	13590.00	N/A	15332.00	10518.21	12345.02	12342.10	27121	H448	L382	N/A
A6154.100.24V	3589.00.24V	13590.00	N/A	15332.00	10518.21	12345.02	12342.10	27121	H466	N/A	N/A
A6154.200.24V	3589.00.24V	13590.00	N/A	15332.00	10518.21	12345.02	12342.10	27121	H466	L241	N/A
A6354.100.DV	13002.00	13002.00	N/A	N/A	10518.23	12345.02	12342.10	N/A	N/A	N/A	10085
A6354.200.LDV	13002.00	13002.00	N/A	N/A	10518.23	12345.02	12342.10	N/A	N/A	N/A	10085
A6754.100.DV	13606.53	N/A	N/A	N/A	10518.28	12345.02	12342.10	N/A	N/A	N/A	10085
A6754.200.LDV	13606.53	N/A	N/A	N/A	10518.28	12345.02	12342.10	N/A	N/A	N/A	10085

BRITAX LIGHTBARS
ARE AVAILABLE FROM
SPECIALIST DISTRIBUTORS
WORLDWIDE
WWW.BRITAX-PMG.COM

A6 SERIES BARS 1500MM 2 + 4 MODULE

CENTRE SECTION SUPPORT BAR FOR THIS ITEM 11298.00

Part Number	Module	Module Inner Pair	Drive Belt	Link Belt	Lens	Centre Section	Bridge Piece	Bulb Clip	Module Bulb	Centre Sec Bulb	Fresnel Lens
A6282.100.12V	13551.04	N/A	15214	N/A	10519.22	12345.02	12342.10	27031	H448	N/A	N/A
A6282.200.12V	13551.04	N/A	15214	N/A	10519.22	12345.02	12342.10	27031	H448	L382	N/A
A6282.100.24V	13551.04	N/A	15214	N/A	10519.22	12345.02	12342.10	27031	H466	N/A	N/A
A6282.200.24V	13551.04	N/A	15214	N/A	10519.22	12345.02	12342.10	27031	H466	L241	N/A
A6382.100.DV	13002.00	N/A	N/A	N/A	10519.23	12345.02	12342.10	N/A	N/A	N/A	10085
A6382.200.LDV	13002.00	N/A	N/A	N/A	10519.23	12345.02	12342.10	N/A	N/A	N/A	10085
A6782.100.DV	13606.53	N/A	N/A	N/A	10519.27	12345.02	12342.10	N/A	N/A	N/A	10085
A6782.200.LDV	13606.53	N/A	N/A	N/A	10519.27	12345.02	12342.10	N/A	N/A	N/A	10085

A6 SERIES BARS 1500MM 2 + 4 MODULE

CENTRE SECTION SUPPORT BAR FOR THIS ITEM 11298.01

Part Number	Module	Module Inner Pair	Drive Belt	Link Belt	Lens	Centre Section	Bridge Piece	Bulb Clip	Module Bulb	Centre Sec Bulb	Fresnel Lens
A6274.100.12V	13551.04	13551.04	15214	N/A	10518.22	12345.01	12342.10	27031	H448	N/A	N/A
A6274.200.12V	13551.04	13551.04	15214	N/A	10518.22	12345.01	12342.10	27031	H448	L382	N/A
A6274.100.24V	13551.04	13551.04	15214	N/A	10518.22	12345.01	12342.10	27031	H466	N/A	N/A
A6274.200.24V	13551.04	13551.04	15214	N/A	10518.22	12345.01	12342.10	27031	H466	L241	N/A
A6174.100.12V	13589.00.12V	13590.00	N/A	15332.00	10518.21	12345.01	12342.10	27121	H448	N/A	N/A
A6174.200.12V	13589.00.12V	13590.00	N/A	15332.00	10518.21	12345.01	12342.10	27121	H448	L382	N/A
A6174.100.24V	13589.00.24V	13590.00	N/A	15332.00	10518.21	12345.01	12342.10	27121	H466	N/A	N/A
A6174.200.24V	13589.00.24V	13590.00	N/A	15332.00	10518.21	12345.01	12342.10	27121	H466	L241	N/A
A6374.100.DV	13002.00	13002.00	N/A	N/A	10518.23	12345.01	12342.10	N/A	N/A	N/A	10085
A6374.200.LDV	13002.00	13002.00	N/A	N/A	10518.23	12345.01	12342.10	N/A	N/A	N/A	10085
A6774.100.DV	13606.53	N/A	N/A	N/A	10518.28	12345.01	12342.10	N/A	N/A	N/A	10085
A6774.200.LDV	13606.53	N/A	N/A	N/A	10518.28	12345.01	12342.10	N/A	N/A	N/A	10085

ALL 'A6' SERIES LIGHTBAR - MOUNTING KIT = K32.00 RETRO FIT WORKLAMP KIT = K49.00

ACCREDITED TO
BS EN ISO9001 & ISO14001
FOR ENVIRONMENTAL
STANDARDS

A13 SERIES LOW PROFILE LED 770MM

Part Number	Module	Module Inner Pair	Drive Belt	Link Belt	End Lens	Centre Lens	Styling Section	Bridge Piece	Bulb Clip	Centre Sec Bulb	Fresnel Lens
A13720.000.DV	N/A	N/A	N/A	N/A	10560.21	N/A	12412.10	N/A	N/A	N/A	N/A
A13720.040.DV	N/A	N/A	N/A	N/A	10560.52	N/A	12412.10	N/A	N/A	N/A	N/A
A13722.000.LDV	N/A	N/A	N/A	N/A	10560.22	N/A	12412.10	N/A	N/A	N/A	N/A
A13722.040.LDV	N/A	N/A	N/A	N/A	10560.53	N/A	12412.10	N/A	N/A	N/A	N/A

A13 SERIES LOW PROFILE LED 1000MM

Part Number	Module	Module Inner Pair	Drive Belt	Link Belt	End Lens	Centre Lens	Styling Section	Bridge Piece	Bulb Clip	Centre Sec Bulb	Fresnel Lens
A13730.100.DV	N/A	N/A	N/A	N/A	10560.21	12411.02	12412.10	N/A	N/A	N/A	N/A
A13730.140.DV	N/A	N/A	N/A	N/A	10560.52	12411.05	12412.10	N/A	N/A	N/A	N/A
A13730.200.DV	N/A	N/A	N/A	N/A	10560.21	12411.02	12412.10	N/A	N/A	N/A	N/A
A13730.240.DV	N/A	N/A	N/A	N/A	10560.52	12411.05	12412.10	N/A	N/A	N/A	N/A
A13732.100.LDV	N/A	N/A	N/A	N/A	10560.22	12411.02	12412.10	N/A	N/A	N/A	N/A
A13732.140.LDV	N/A	N/A	N/A	N/A	10560.53	12411.05	12412.10	N/A	N/A	N/A	N/A
A13732.200.LDV	N/A	N/A	N/A	N/A	10560.22	12411.02	12412.10	N/A	N/A	N/A	N/A
A13732.240.DV	N/A	N/A	N/A	N/A	10560.53	12411.05	12412.10	N/A	N/A	N/A	N/A

A13 SERIES LOW PROFILE LED 1250MM

Part Number	Module	Module Inner Pair	Drive Belt	Link Belt	End Lens	Centre Lens	Styling Section	Bridge Piece	Bulb Clip	Centre Sec Bulb	Fresnel Lens
A13750.100.DV	N/A	N/A	N/A	N/A	10560.21	12411.01	12412.10	N/A	N/A	N/A	N/A
A13750.140.DV	N/A	N/A	N/A	N/A	10560.52	12411.04	12412.00	N/A	N/A	N/A	N/A
A13750.200.DV	N/A	N/A	N/A	N/A	10560.21	12411.01	12412.10	N/A	N/A	N/A	N/A
A13750.240.DV	N/A	N/A	N/A	N/A	10560.52	12411.04	12412.10	N/A	N/A	N/A	N/A
A13752.100.LDV	N/A	N/A	N/A	N/A	10560.22	12411.01	12412.10	N/A	N/A	N/A	N/A
A13752.140.LDV	N/A	N/A	N/A	N/A	10560.53	12411.04	12412.10	N/A	N/A	N/A	N/A
A13752.200.LDV	N/A	N/A	N/A	N/A	10560.22	12411.01	12412.10	N/A	N/A	N/A	N/A
A13752.240.LDV	N/A	N/A	N/A	N/A	10560.53	12411.04	12412.10	N/A	N/A	N/A	N/A

A13 SERIES LOW PROFILE LED 1500MM

Part Number	Module	Module Inner Pair	Drive Belt	Link Belt	End Lens	Centre Lens	Styling Section	Bridge Piece	Bulb Clip	Centre Sec Bulb	Fresnel Lens
A13770.100.DV	N/A	N/A	N/A	N/A	10560.21	12411.00	12412.10	N/A	N/A	N/A	N/A
A13770.140.DV	N/A	N/A	N/A	N/A	10560.52	12411.03	12412.00	N/A	N/A	N/A	N/A
A13770.200.DV	N/A	N/A	N/A	N/A	10560.21	12411.00	12412.10	N/A	N/A	N/A	N/A
A13770.240.DV	N/A	N/A	N/A	N/A	10560.52	12411.03	12412.10	N/A	N/A	N/A	N/A
A13772.100.LDV	N/A	N/A	N/A	N/A	10560.22	12411.00	12412.10	N/A	N/A	N/A	N/A
A13772.140.LDV	N/A	N/A	N/A	N/A	10560.53	12411.03	12412.10	N/A	N/A	N/A	N/A
A13772.200.LDV	N/A	N/A	N/A	N/A	10560.22	12411.00	12412.10	N/A	N/A	N/A	N/A
A13772.240.LDV	N/A	N/A	N/A	N/A	10560.53	12411.03	12412.10	N/A	N/A	N/A	N/A

ROUTINELY TESTED
FOR LOW / HIGH TEMPERATURE
PERFORMANCE
-30°C TO 50°C

Index

MINI BARS PAGE

A421.00.12V.....	06
A421.00.24V.....	06
A424.00.12V.....	06
A424.00.24V.....	06
A431.00.DV.....	06
A434.00.DV.....	06
A451.00.LMV.....	06
A454.00.LMV.....	06
A481.00.LDV.....	06
A484.00.LDV.....	06
A491.00.LDV.....	06
A494.00.LDV.....	06
A491.40.LDV.....	06
A494.40.LDV.....	06

MICRO BARS PAGE

A100.00.LDV.....	07
A101.00.LDV.....	07
A501.00.LDV.....	07
A504.00.LDV.KIT.....	07
A511.00.LDV.....	07
A514.00.LDV.KIT.....	07

A6 SERIES AEROLITE BARS PAGE

A6202.100.12V.....	06
A6202.100.24V.....	06
A6302.000.DV.....	06
A6702.000.DV.....	06
A6602.000.LDV.....	06
A6212.100.12V.....	08
A6212.200.12V.....	08
A6212.100.24V.....	08
A6212.200.24V.....	08
A6312.100.DV.....	08
A6312.200.DV.....	08
A6712.100.DV.....	08
A6712.200.DV.....	08
A6612.100.LDV.....	08
A6612.200.LDV.....	08
A6124.000.12V.....	08
A6124.000.24V.....	08
A6224.000.12V.....	08
A6224.000.24V.....	08
A6324.000.DV.....	08
A6724.000.DV.....	08
A6624.000.LDV.....	08
A13720.000.DV.....	08
A13720.040.DV.....	08
A13722.000.LDV.....	08

A13722.040.LDV.....	08
A6242.100.12V.....	08
A6242.200.12V.....	08
A6242.100.24V.....	09
A6242.200.24V.....	09
A6234.100.12V.....	09
A6234.200.12V.....	09
A6234.100.24V.....	09
A6234.200.24V.....	09
A6134.100.12V.....	09
A6134.200.12V.....	09
A6134.100.24V.....	09
A6134.200.24V.....	09
A6342.100.DV.....	09
A6342.200.LDV.....	09
A6334.100.DV.....	09
A6334.200.LDV.....	09
A6742.100.DV.....	09
A6742.200.LDV.....	09
A6642.100.LDV.....	09
A6642.200.LDV.....	09
A6734.100.DV.....	09
A6734.200.LDV.....	09
A6634.100.LDV.....	09
A6634.200.LDV.....	09
A6262.100.12V.....	10
A6262.200.12V.....	10
A6262.100.24V.....	10
A6262.200.24V.....	10
A6254.100.12V.....	10
A6254.200.12V.....	10
A6254.100.24V.....	10
A6254.200.24V.....	10
A6154.100.12V.....	10
A6154.200.12V.....	10
A6154.100.24V.....	10
A6154.200.24V.....	10
A6362.100.DV.....	10
A6362.200.LDV.....	10
A6354.100.DV.....	10
A6354.200.LDV.....	10
A6762.100.DV.....	10
A6762.200.LDV.....	10
A6662.100.LDV.....	10
A6662.200.LDV.....	10
A6754.100.DV.....	10
A6754.200.LDV.....	10
A6654.100.DV.....	10
A6654.200.LDV.....	10
A6282.100.12V.....	11
A6282.200.12V.....	11
A6282.100.24V.....	11
A6282.200.24V.....	11
A6274.100.12V.....	11
A6274.100.24V.....	11
A6274.100.24V.....	11

A6274.200.24V.....	11
A6174.0100.12V.....	11
A6174.200.12V.....	11
A6174.100.24V.....	11
A6174.200.24V.....	11
A6382.100.DV.....	11
A6382.200.LDV.....	11
A6374.100.DV.....	11
A6374.200.LDV.....	11
A6782.200.DV.....	11
A6782.200.LDV.....	11
A6682.100.DV.....	11
A6682.200.LDV.....	11
A6774.100.DV.....	11
A6774.200.LDV.....	11
A6674.100.DV.....	11
A6674.200.LDV.....	11

A13 LOW PROFILE LED BARS PAGE

A12708.000.DV.....	07
A12738.000.DV.....	07
A12738.001.DV.....	07
A12738.100.DV.....	07
A12759.000.DV.....	07
A12759.001.DV.....	07
A12759.002.DV.....	07
A12759.100.DV.....	07
A12779.000.DV.....	07
A13720.000.DV.....	08
A13720.040.DV.....	08
A13722.000.LDV.....	08
A13722.040.LDV.....	08
A13730.100.DV.....	08
A13730.140.DV.....	08
A13730.200.DV.....	08
A13730.240.DV.....	08
A13732.100.LDV.....	08
A13732.140.LDV.....	08
A13732.200.LDV.....	08
A13732.240.DV.....	08
A13750.100.DV.....	10
A13750.140.DV.....	10
A13750.200.DV.....	10
A13750.240.DV.....	10
A13752.100.LDV.....	10
A13752.140.LDV.....	10
A13752.200.LDV.....	10
A13752.240.LDV.....	10
A13770.100.DV.....	11
A13770.140.DV.....	11
A13770.200.DV.....	11
A13770.240.DV.....	11
A13772.100.LDV.....	11
A13772.140.LDV.....	11
A13772.200.LDV.....	11
A13772.240.LDV.....	11

A6 RECOVERY & SPECIALIST BARS PAGE

A6637.100.LDV.....	12
A6657.100.LDV.....	12
A6677.100.LDV.....	12
A6656.300.LDV.....	12
A6676.300.LDV.....	12
A6546.200.12V.....	12
A6546.200.24V.....	12
A6556.200.12V.....	12
A6556.200.24V.....	12
A6546.300.12V.....	12
A6546.300.24V.....	12
A6556.300.12V.....	12
A6556.300.24V.....	12

SIGN PLATE LETTERING PAGE

12005.10.....	13
12005.13.....	13
12005.79.....	13
12005.26.....	13
12005.87.....	13
12005.101.....	13
12005.77.....	13
12005.89.....	13
12005.86.....	13
12005.19.....	13
12005.59.....	13
12005.109.....	13
12005.99.....	13
12005.49.....	13
12005.64.....	13
12005.76.....	13
12005.91.....	13
12005.61.....	13
12005.36.....	13
12005.85.....	13
12005.07.....	13
12005.35.....	13
12005.28.....	13
12005.55.....	13
12005.73.....	13
12005.50.....	13
12005.57.....	13
12005.00.....	13
12005.23.....	13
12005.22.....	13
12005.63.....	13
12005.78.....	13
12005.39.....	13
12005.09.....	13
12005.12.....	13
12005.110.....	13